

PRODUKTSAMMLUNG
PRODUCT COLLECTION



LED UP

The logo features the words "LED" and "UP" in a bold, black, sans-serif font. The letters are set against a background of horizontal, multi-colored motion blur lines in shades of blue, red, yellow, and white. The entire logo is enclosed within a red rectangular border.

frame your
inspiration



BIG LEDUP

- größtes, mobiles LED-Display am Markt

- Material - silber eloxierte Aluminiumprofile, 120 mm Bautiefe mit Aluminiumgussverbindern
- einfacher, werkzeugloser Aufbau dank innovativem Stecksystem
- 76 standard Rahmenformate, beginnend mit einem Startmodul können Rahmen bis zu einer Größe von 500x300cm ausgebaut werden
 - Sondergrößen verfügbar
- TV-Halter für Monitore (bis 10kg), VESA 200 und 400 als Zubehör
- Leuchtkraft z.B. B 200 x H 245 cm ca. 186 Watt
- Unterschiedliche Aufstellvarianten möglich:
 - Systemverbinder aus Metall - Aufstellformen L-, U-, T-, Kreuz & Sternform
- Kombination mit unbeleuchtetem BIG UP möglich
- ABS-Transportkoffer mit Weichschaumeinlage für maximalen Schutz

- largest, mobile light box on the market

- material - silver anodized aluminum profiles, depth only 120 mm, with aluminum die-cast connectors
- easy, tool-less assembly thanks to innovative plug-in system
- standard frame sizes, beginning with a start module, frames can be expanded up to a size of 500x300cm
 - Custom sizes available
- TV holder for monitors (up to 10kg), VESA 200 and 400 as an accessory
- luminance e.g. W 200 x H 245 cm approx. 186 Watt
- Various Installation options are possible
 - System connector made of steel - create various shapes like L-, U-, T-, cross or star shape
- Combination with non-illuminated BIG UP is also possible
- ABS transport case with soft foam insert for maximum protection

BIG LED UP



Profildesign / profile design

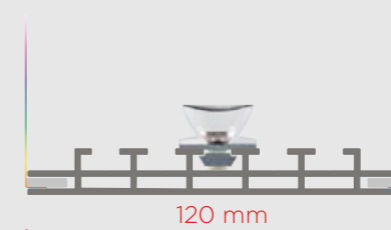

homogene Ausleuchtung dank qualitativ hochwertiger OSRAM LED Technik mit speziell angepasster Linsenform

even lighting using OSRAM LED technique including a specially adapted lens

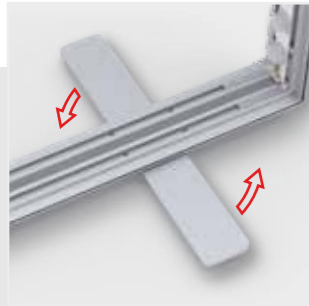
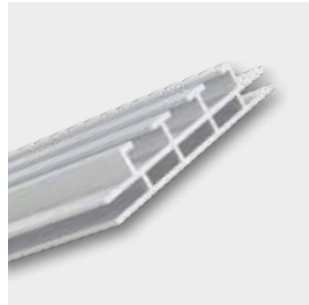

LEDUP

- leichtes, mobiles Leuchtrahmensystem

- Material - silber eloxierte Aluminiumprofile, 80 mm Bautiefe, mit Aluminiumgussverbindern
- 6 standard Rahmenformate 85x200 cm, 85x230 cm, 85x245 cm, 100x200 cm, 100x230 cm und 100x245 cm inkl. ausklappbaren Füßen (Rahmenhöhe +2 cm), nur ca. 9,5 kg Systemgewicht
- endlose Verbindung mehrerer Rahmen möglich
- Verbindungskabel, einfach zum Verstecken. Mit einem Stromanschluss bis zu 10 LEDUPs verbinden
- einfacher, werkzeugloser Aufbau dank innovativem Stecksystem - nur 7 Teile
- Leuchtkraft z.B. B 85 x H 200 cm ca. 59 Watt, 12.600 lm
- Pogo pin Lichttechnik mit hocheffizienten LED Modulen
- umweltfreundliche Kartonverpackung mit Griff und Aufbewahrungskammer für die Stoffpaneele, alternativ auch im ABS Transportkoffer erhältlich

- lightweight, mobile light box display

- material - silver anodized aluminum profiles, depth only 80 mm, with aluminum die-cast connectors
- 6 standard frame sizes 85x200 cm, 85x230 cm, 85x245 cm, 100x200 cm, 100x230 cm and 100x245 cm incl. fold-out bases (frame height +2 cm), only approx. 9,5 kg system weight
- endless connection of several frames possible
- Connection cable, easy to hide. Connect up to 10 LEDUPs to a power connector
- easy, tool-less assembly thanks to innovative plug-in system - only 7 parts
- luminance e.g. W 85 x H 245 cm approx. 59 Watt, 12.600 lm
- pogo pin lighting technology with highly efficient LED modules
- eco-friendly cardboard packaging with handle and storage for the fabric panels, alternatively also available with ABS carrying case

LEDUP



Profildesign / profile design

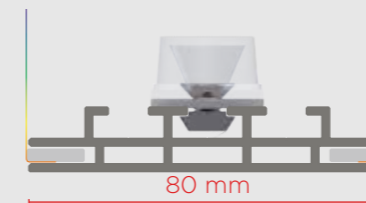

homogene Ausleuchtung dank qualitativ hochwertiger OSRAM LED Technik mit speziell angepasster Linsenform

even lighting using OSRAM LED technique including a specially adapted lens

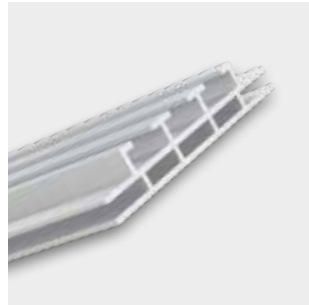

LEDUP BATTERY

- leichtes, mobiles Leuchtrahmensystem mit Lithium - Ionen Akku (10 Stunden)

- Material - silber eloxierte Aluminiumprofile, 80 mm Bautiefe, mit Aluminiumgussverbindern
- Rahmenformat 100x200 cm inkl. ausklappbaren Füßen (Rahmenhöhe +2 cm)
- Pogo pin Lichttechnik mit hocheffizienten LED Modulen - 59 Watt, 12.600 lm
- Verpackt im ABS Transportkoffer mit Handgriff und leichtgängigen Rollen
- endlose Verbindung mehrerer Rahmen möglich
- einfacher, werkzeugloser Aufbau dank innovativem Stecksystem
- inkl. Akku mit 22Ah für eine Leuchtdauer von über 10 Stunden

- light, mobile illuminated frame system with lithium-ion powerpack (10 hours)

- material - silver anodized aluminum profiles, depth only 80 mm, with aluminum die-cast connectors
- frame size 100x200 cm incl. fold-out bases (frame height +2 cm)
- pogo pin lighting technology with highly efficient LED modules - 59 Watt, 12.600 lm
- packed in an ABS transport case with handle and smooth-running wheels
- endless connection of several frames possible
- easy, tool-less assembly thanks to innovative plug-in system
- incl. powerpack with 22Ah for a lighting time of over 10 hours

LEDUP BATTERY

Wiederaufladbarer 24 Volt Lithium - Ionen Akku
/rechargeable 24 volt lithium-ion powerpack



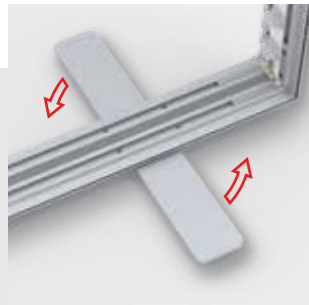
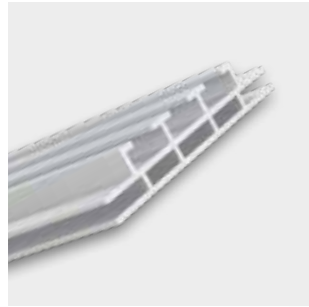

LEDUP Sanitizer

- mobiles Leuchtrahmensystem mit Desinfektionsmittelpender

- Material - silber eloxierte Aluminiumprofile, 80 mm Bautiefe, mit Aluminiumgussverbindern
- 4 standard Rahmenformate 85x146,5 cm, 85x200 cm und 100x146,5 cm, 100x200 cm inkl. ausklappbaren Füßen (Rahmenhöhe +2 cm), nur ca. 9,5 kg Systemgewicht
- berührungsloser Händedesinfektionsmittelpender aus Edelstahl (Unterkante 120 cm) mit einer Füllmenge von 600 ml
- einfacher, werkzeugloser Aufbau dank innovativem Stecksystem - nur 7 Teile
- Plug & Play Lichttechnik mit hocheffizienten OSRAM LED Modulen
- umweltfreundliche Kartonverpackung mit Griff und Aufbewahrungskammer für die Stoffpaneele, alternativ auch im ABS Transportkoffer erhältlich

- mobile light box display with hand sanitizer dispenser

- material - silver anodized aluminium profiles, depth only 80 mm with aluminium die-cast connectors
- 4 standard frame sizes 85x146,5 cm, 85x200 cm und 100x146,5 cm, 100x200 cm incl. fold-out bases (frame height +2 cm), only approx. 9,5 kg system weight
- touchless hand sanitizer dispenser made of stainless steel (lower edge 120 cm) with a capacity of 600 ml
- easy, tool-less assembly thanks to innovative plug-in system - only 7 parts
- plug & play lighting technology with highly efficient OSRAM LED modules
- eco-friendly cardboard packaging with handle and storage for the fabric panels, alternatively also available with ABS carrying case

LEDUP
SANITIZER



Profildesign / profile design

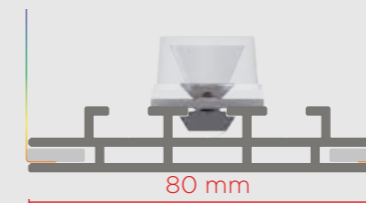

homogene Ausleuchtung dank qualitativ hochwertiger OSRAM LED Technik mit speziell angepasster Linsenform

even lighting using OSRAM LED technique including a specially adapted lens

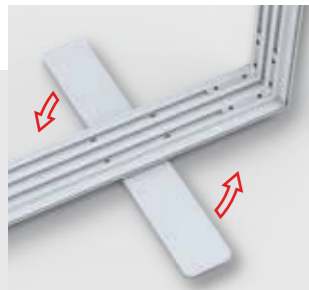

MINI LEDUP

- mobiles Rahmensystem

- Material - silber eloxierte Aluminiumprofile, 80 mm Bautiefe, mit Aluminiumgussverbindern
- standard Rahmenformat 50x150 cm, inkl. ausklappbarem Fuß nur ca. 6,9 kg Systemgewicht
- einfacher, werkzeugloser Aufbau dank innovativem Stecksystem
- Plug & Play Lichttechnik mit hocheffizienten LED Modulen
- umweltfreundliche Kartonverpackung

- mobile light box display

- material - silver anodized aluminium profiles, depth only 80 mm, with aluminium die-cast connectors
- standard frame size 50x150 cm incl. fold-out foot, only approx. 6,9 kg system weight
- easy, tool-less assembly thanks to innovative plug-in system
- plug & play lighting technology with highly efficient LED modules
- eco-friendly cardboard packaging

MINI LEDUP



Profildesign / profile design

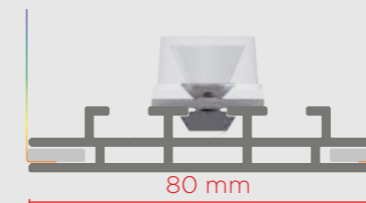

homogene Ausleuchtung dank qualitativ hochwertiger OSRAM LED Technik mit speziell angepasster Linsenform

even lighting using OSRAM LED technique including a specially adapted lens

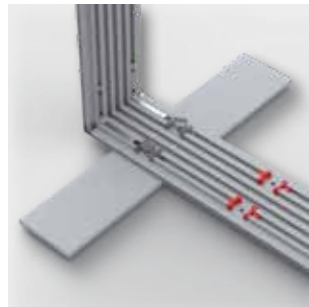
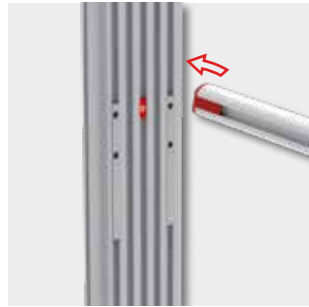
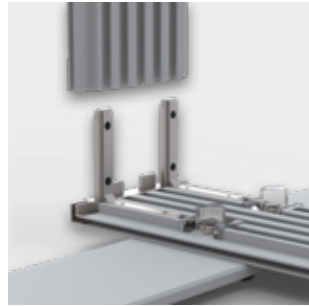

BIG UP

BIG UP

- mobiles Rahmensystem in mehr als 2 Mio. Aufstellgrößen erhältlich

- Material - silber eloxierte Aluminiumprofile, 120 mm Bautiefe, mit Aluminiumgussverbindern
- 12 standard Rahmenformate:
200x200/248/298 cm, 300x200/248/298 cm,
400x200/248/298 cm, 500x200/248/298 cm
- Sondergrößen - Millimeter genau nach Kundenwunsch in Standardlieferzeit auslieferbar
- einfacher, werkzeugloser Aufbau dank innovativem Stecksystem
- Systemverbinder aus Metall - Aufstellformen L-, U-, T-, Kreuz & Sternform
- Kombination mit BIG LEDUP möglich
- ABS-Transportkoffer mit Weichschaumeinlage für maximalen Schutz

- mobile frame system available in more than 2 million installation sizes

- material - silver anodized aluminium profiles, depth only 120 mm, with aluminium die-cast connectors
- 12 standard frame sizes:
200x200/248/298 cm, 300x200/248/298 cm,
400x200/248/298 cm, 500x200/248/298 cm
- Special sizes - Accurate to the millimeter according to customer requirements
- simple, tool-free assembling thanks to the innovative plug-in system
- System connector made of steel - shapes: L-, U-, T-, cross or star shape
- Combination with BIG LEDUP possible
- ABS transport case with special foam lining for maximum protection

Profildesign / profile design



Material - silber eloxierte Aluminiumprofile mit Stahlverbindereinfache Montage und schneller Motivwechsel

material - silver anodized aluminium profiles with steel connectors easy to assemble and graphics change easily

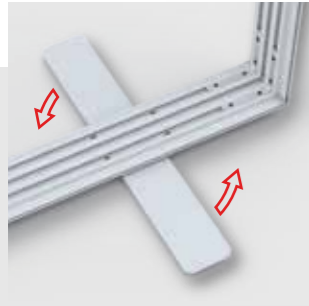

PICUP

- leichtes, mobiles Rahmensystem

- Material - silber eloxierte Aluminiumprofile mit Aluminiumgussverbindern
- 6 standard Rahmenformate:
85x200 cm, 85x230 cm, 85x245 cm, 100x200 cm, 100x230 cm und 100x245 cm
- Bautiefe nur 80 mm
- endlose Verbindung mehrerer Rahmen möglich
- einfacher, werkzeugloser Aufbau dank innovativem Stecksystem - nur 7 Teile
- umweltfreundliche Kartonverpackung mit Griff und Aufbewahrungskammer für die Stoffpaneele
- nur ca. 7,5 kg Systemgewicht

- lightweight, mobile display

- material - silver anodized aluminium profiles with aluminium die-cast connectors
- 6 standard frame sizes:
85x200 cm, 85x230 cm, 85x245 cm, 100x200 cm, 100x230 cm and 100x245 cm,
- depth only 80 mm
- endless connection of several frames possible
- easy, tool-less assembly thanks to innovative plug-in system - only 7 parts
- eco-friendly cardboard packaging with handle and storage for the fabric panels
- only approx. 7,5 kg system weight

PICUP

Profildesign / profile design

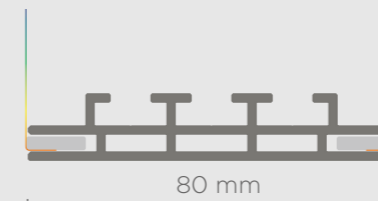

Material - silber eloxierte Aluminiumprofile mit Stahlverbindereinfache Montage und schneller Motivwechsel

material - silver anodized aluminium profiles with steel connectors easy to assemble and graphics change easily

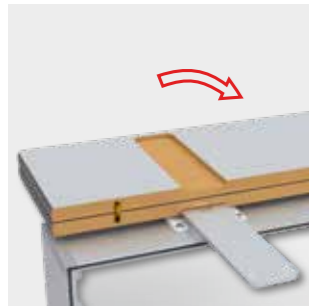
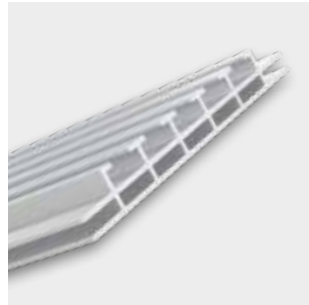

LEDUP COUNTER

- mobiles LED Thekensystem im ABS Transportkoffer

- Material - silber eloxierte Aluminiumprofile 120 mm Bautiefe mit Aluminiumgussverbindern
- beidseitig hinterleuchtet - Rahmenformat 100x100 cm
- einfache Montage durch Plug & Play
- homogene Ausleuchtung dank qualitativ hochwertiger OSRAM LED Technik mit speziell angepasster Linsenform
- Leuchtkraft 43 Watt, 5040 lm, Farbtemperatur 6500 Kelvin
- Systemmaße inkl. Füße BxHxT 100x104x40 cm
- ABS Transportkoffer BxHxT 118x30x12 cm mit Schaumstoffeinlagen, Rollen und Griff
- ca. 21 kg Transportgewicht (ohne Druck)
- aufklappbare Thekenplatte in schwarz oder silber erhältlich

- mobile LED counter in ABS hardcase

- material - silver anodized aluminium profiles depth 120 mm, with aluminium die-cast connectors
- illuminated on both sides - frame size 100x100 cm
- easy installation because of plug & play
- even lighting illumination - using OSRAM LED technique including a specially adapted lens
- luminance 43 Watt, 5040 lm, colour temperature 6500 Kelvin
- system dimensions incl. bases WxHxD 100x104x40 cm
- ABS hardcase WxHxD 118x30x12 cm with special foam lining, wheels and handle
- approx. 21 kg transport weight (prints not included)
- foldable counter top in black or silver available

Profildesign / profile design

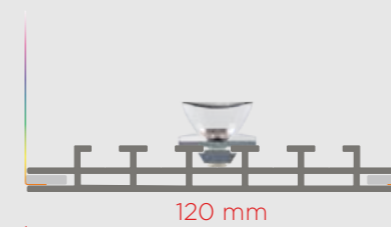

homogene Ausleuchtung dank qualitativ hochwertiger OSRAM LED Technik mit speziell angepasster Linsenform

even lighting using OSRAM LED technique including a specially adapted lens

LEDUP COUNTER

OSRAM
LED Technology included

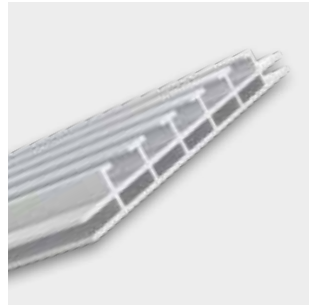

COUNTER ONE

- mobiles LED Thekensystem in ABS Transportkoffer

- beleuchtete Front - Rahmenformat 100x100cm
- einfache Montage dank Plug & Play Lichttechnik
- homogene Ausleuchtung dank qualitativ hochwertiger OSRAM LED Technik mit speziell angepasster Linsenform
- inkl. Zwischenfach und schwarzer Deckplatte
- Systemmaße inkl. Füße BxHxT 100x101,5x48 cm
- ABS Transportkoffer BxHxT 39x30x116 cm mit Schaumstoffeinlagen, Rollen und Griff
- ca. 30 kg Transportgewicht
- optionales Zubehör: wiederaufladbare Lithium - Ionen Akku mit 9 h Leuchtdauer, abschließbare Türen

- mobile LED counter in ABS hardcase

- illuminated front - frame size 100x100 cm
- easy installation thanks to plug & play lighting technology
- even lighting illumination - using OSRAM LED technique including a specially adapted lens
- incl. shelf and black counter top
- system dimensions incl. bases WxHxD 100x101,5x48 cm
- ABS hardcase WxHxD 39x30x116 cm with special foam lining, wheels and handle
- approx. 30 kg transport weight
- optional accessories: rechargeable lithium - ion powerpack with 9 hours illumination, lockable doors

COUNTER ONE



Profildesign / profile design

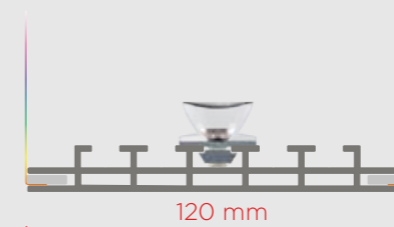

homogene Ausleuchtung dank qualitativ hochwertiger OSRAM LED Technik mit speziell angepasster Linsenform

even lighting using OSRAM LED technique including a specially adapted lens

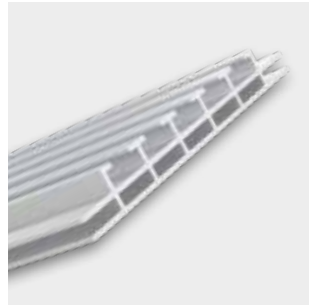

COUNTER MAX

- mobiles LED Thekensystem im ABS Transportkoffer

- beleuchtete Front - Rahmenformat 100x116 cm
- einfache Montage dank Plug & Play Lichttechnik
- homogene Ausleuchtung dank qualitativ hochwertiger OSRAM LED Technik mit speziell angepasster Linsenform
- inkl. Zwischenfach und schwarzer Deckplatte
- Systemmaße inkl. Füße BxHxT 100x118x40 cm
- ABS Transportkoffer BxHxT 40x119x31cm mit Schaumstoffeinlagen, Rollen und Griff
- ca. 30 kg Transportgewicht
- optionales Zubehör: wiederaufladbare Lithium - Ionen Akku mit 9 h Leuchtdauer, abschließbare Türen

- mobile LED counter in ABS hardcase

- illuminated front - frame size 100x116 cm
- easy installation thanks to plug & play lighting technology
- even lighting illumination - using OSRAM LED technique including a specially adapted lens
- incl. shelf and black counter top
- system dimensions incl. bases WxHxD 100x118x40 cm
- ABS hardcase WxHxD 40x119x31 cm with special foam lining, wheels and handle
- approx. 30 kg transport weight
- optional accessories: rechargeable lithium - ion powerpack with 9 hours illumination, lockable doors

COUNTER MAX



Profildesign / profile design

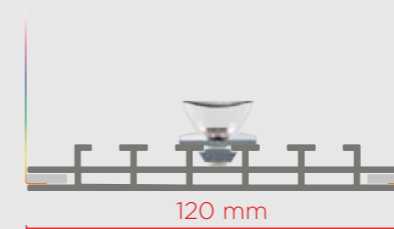

homogene Ausleuchtung dank qualitativ hochwertiger OSRAM LED Technik mit speziell angepasster Linsenform

even lighting using OSRAM LED technique including a specially adapted lens

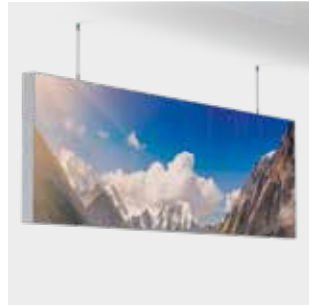

Sonderrahmenbau *custom frame construction*



MULTIFRAME

- Sonderformate nach individuellem Kundenwunsch

- Individuell angepasste Rahmengrößen
- Produktionszeit eine Woche + Versandtage
- Beleuchtet oder unbeleuchtet
- Wand- Deckenmontagen, abgehängt oder freistehend
- Sonderformen möglich
- Verschiedenste Profiltiefen je nach Anwendungsbedarf sind lagernd

- *Special formats according to individual customer requirements*

- *Individually adapted frame sizes*
- *Production time: one week + shipping days*
- *Illuminated or not illuminated*
- *Wall-ceiling mounting, suspended or free-standing*
- *Custom shapes possible*
- *Depending on the application, different profile depths are available*

MULTIframe



BASIC

SUPER SLIM

SIDE LIGHT

